

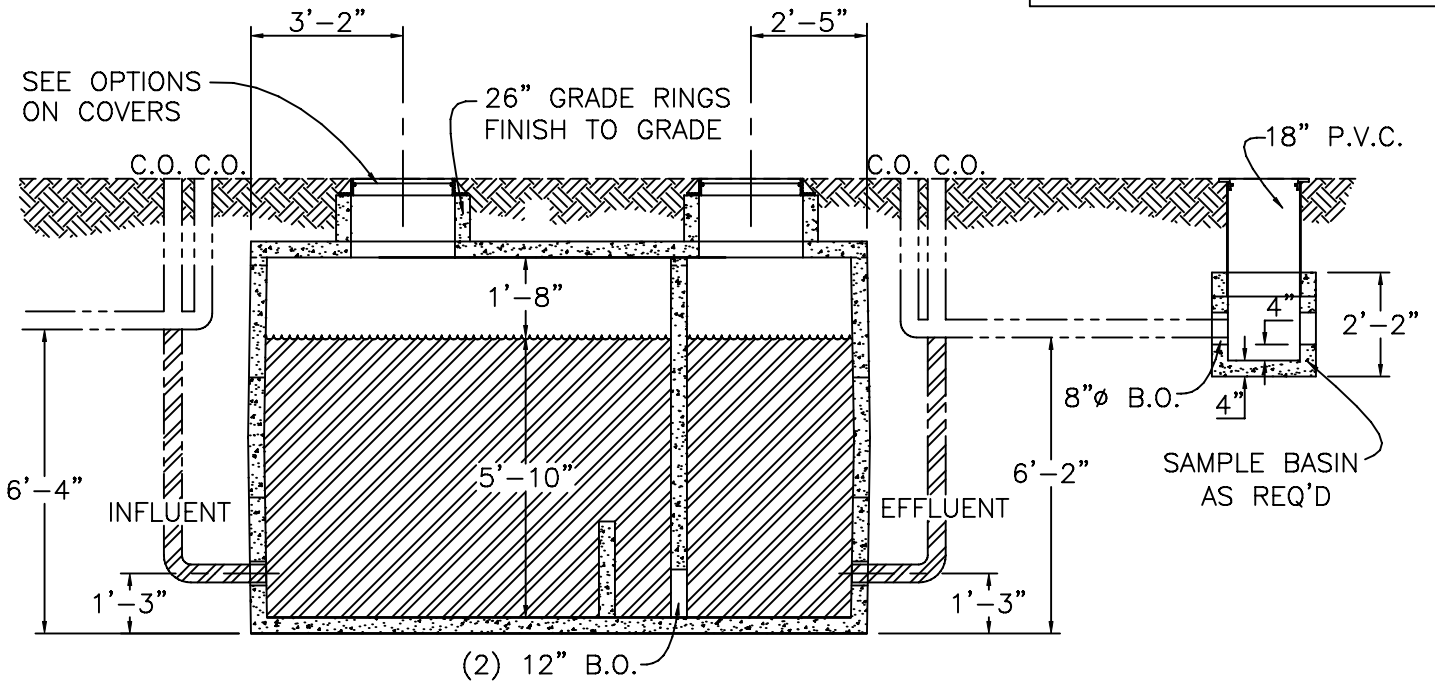

8650 Box Rd.
 Shreveport, LA 71106
 Phone: 318-869-2085
 Fax: 318-869-2098
 800-456-1970

DESIGN SPECIFICATION ASTM C 913.
 NOT DESIGNED FOR TRAFFIC LOADING.
 CALL US FOR SPECIAL SITUATION

4500 P.S.I. CONC.
 REINF. 4X4 4/4 WIRE
 AND #4, GRADE 60 BARS



SCHEMATIC

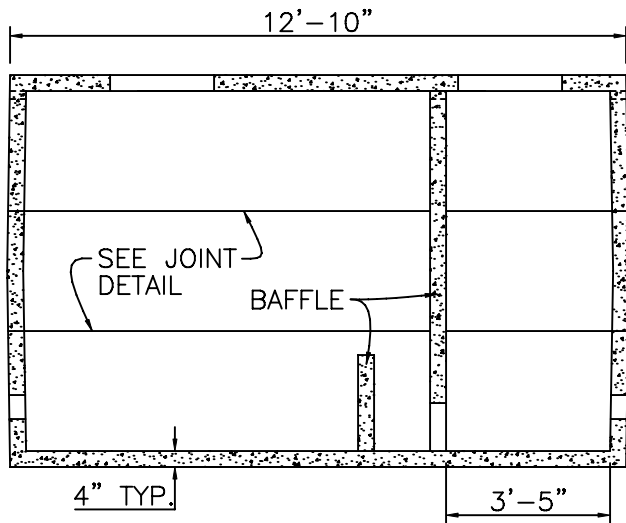

LONG SECTION

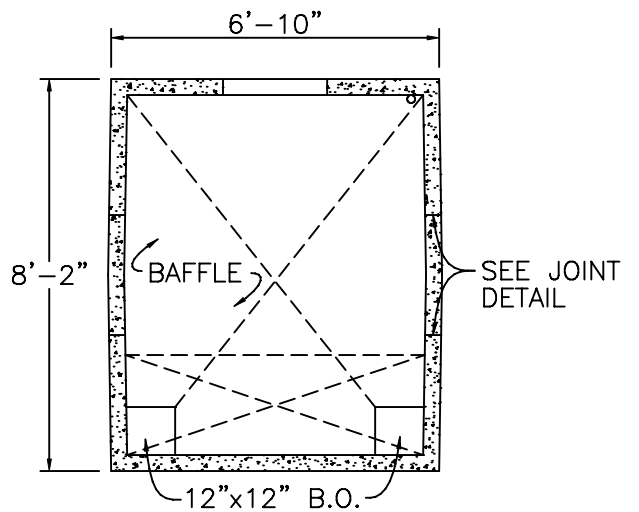

CROSS SECTION

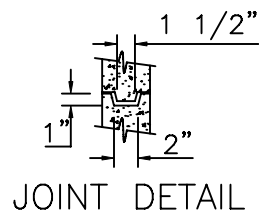

3000 Gal. GREASE INTERCEPTOR	
DRAWN BY: KWD	APP'D BY: SN
DATE: 1/24/07	SCALE: 1/4"=1'-0"